

HP46 / HP81

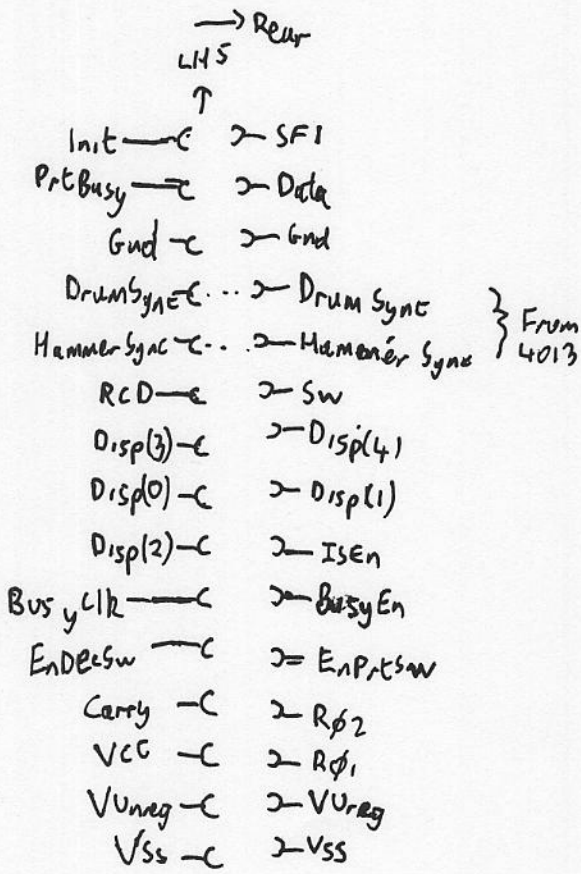

Display PCB

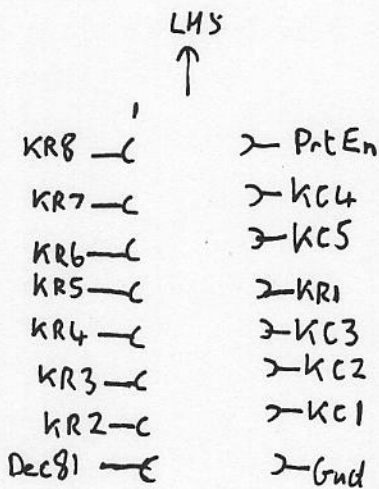

Keyboard



Printer

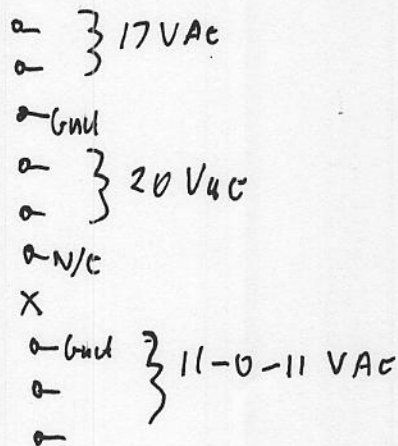

Transformer

MP45 / MP81

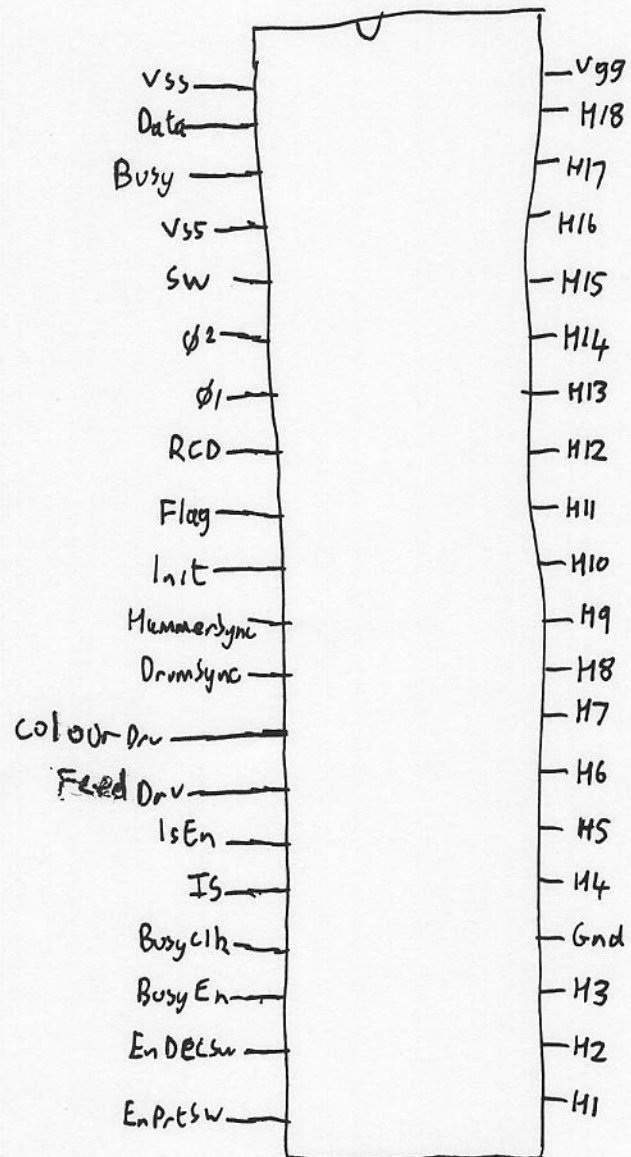

1820-0994

Printer Controller

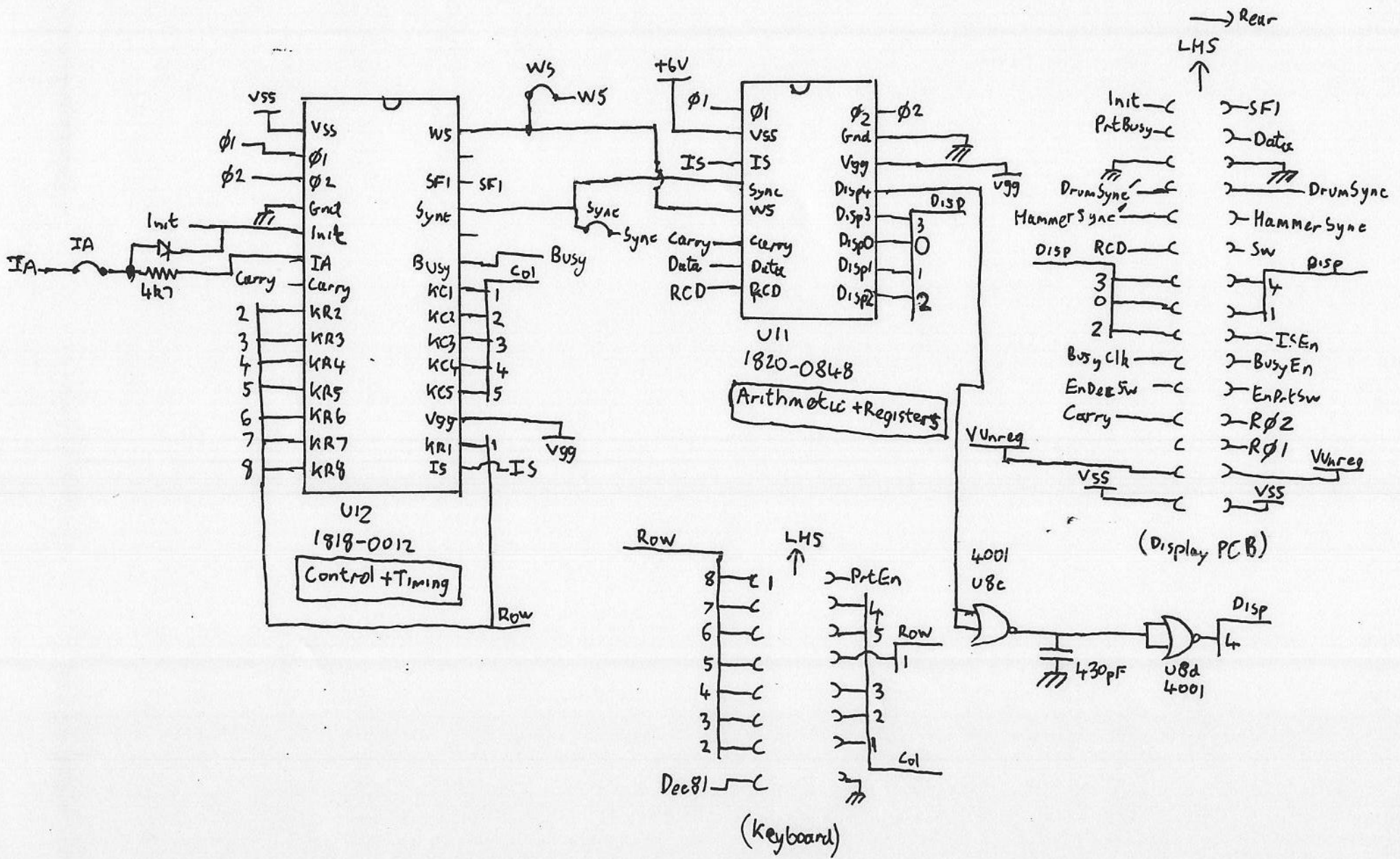

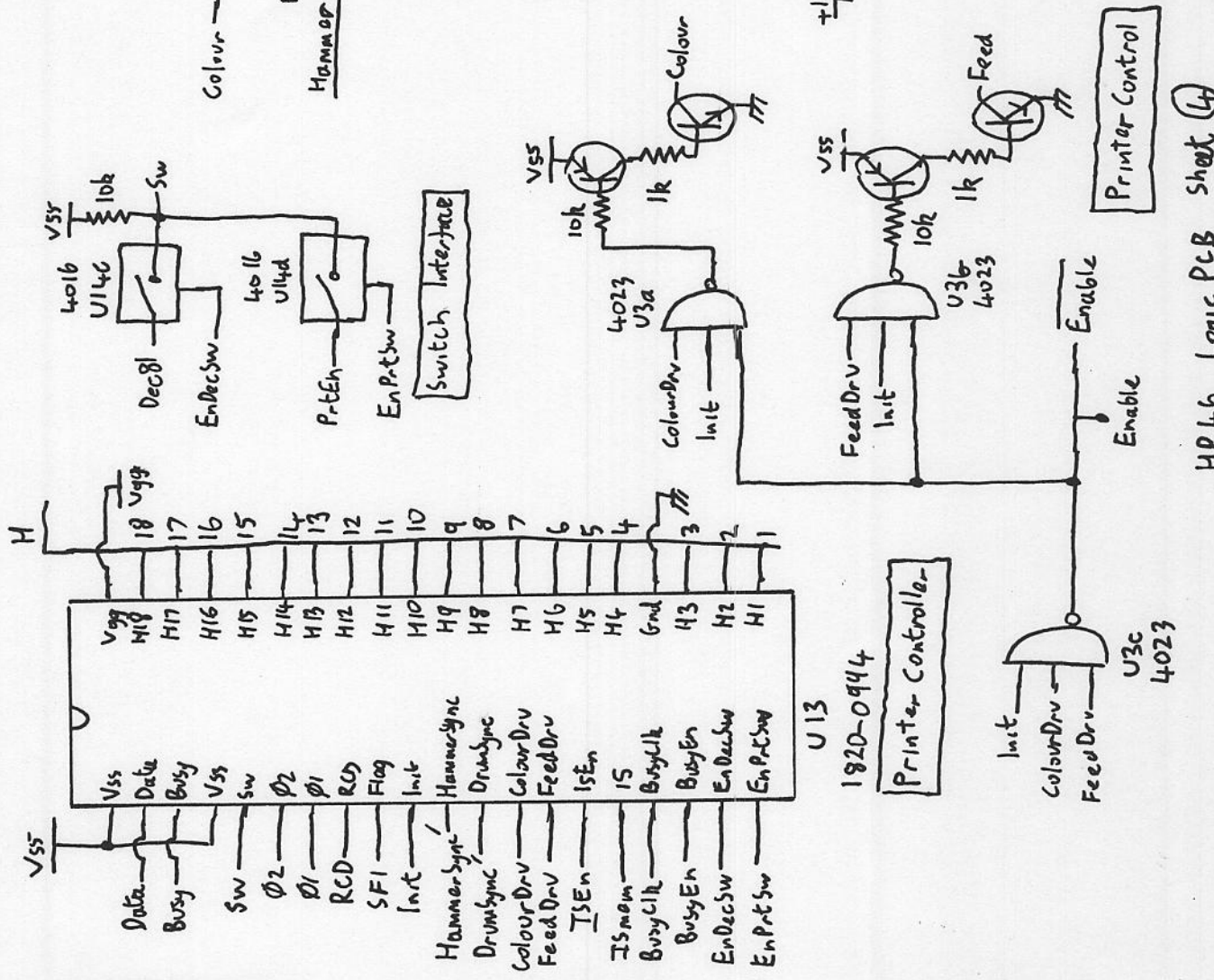
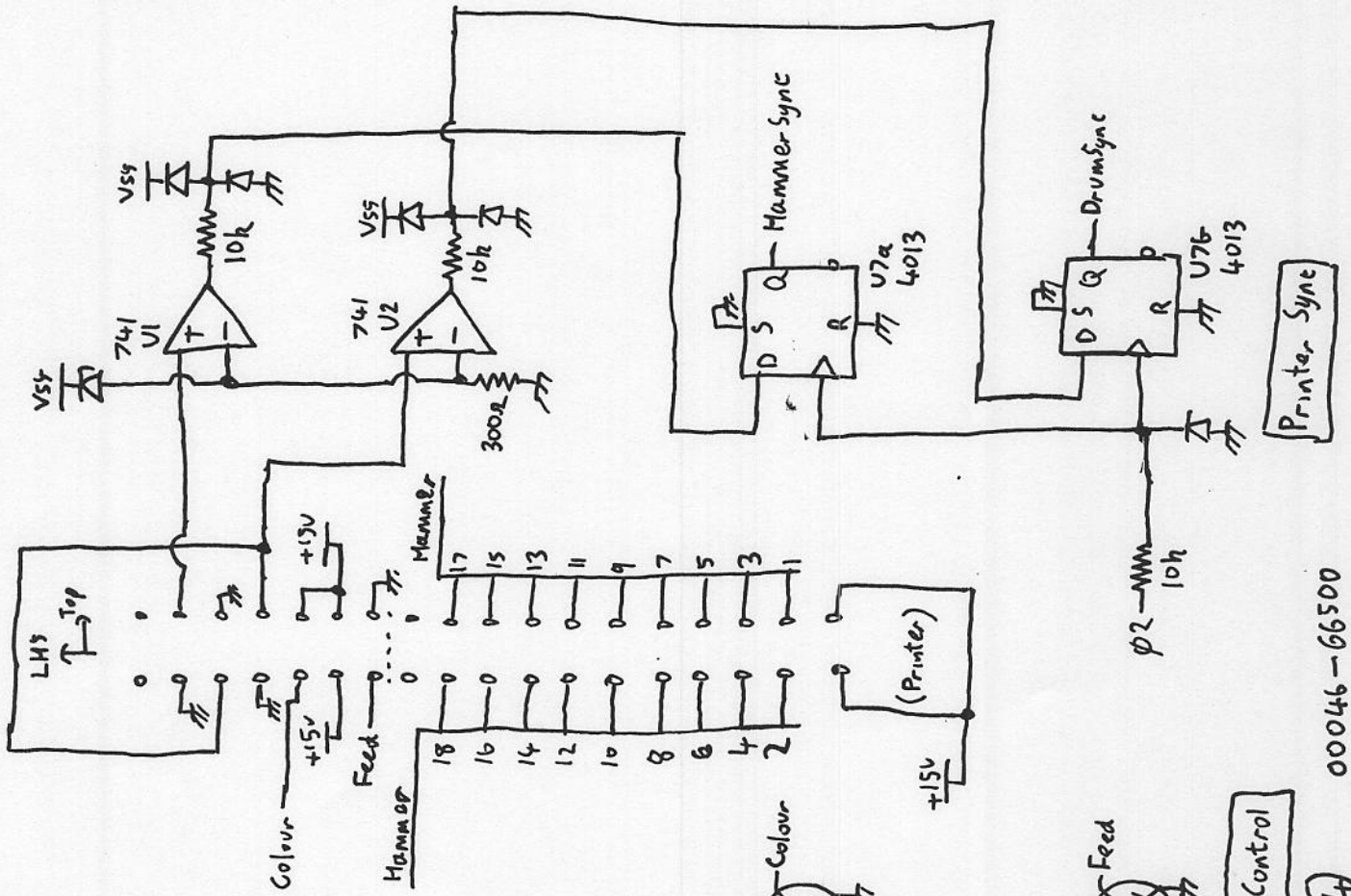

HP 46 Logic PCB sheet (4) 00046-66500

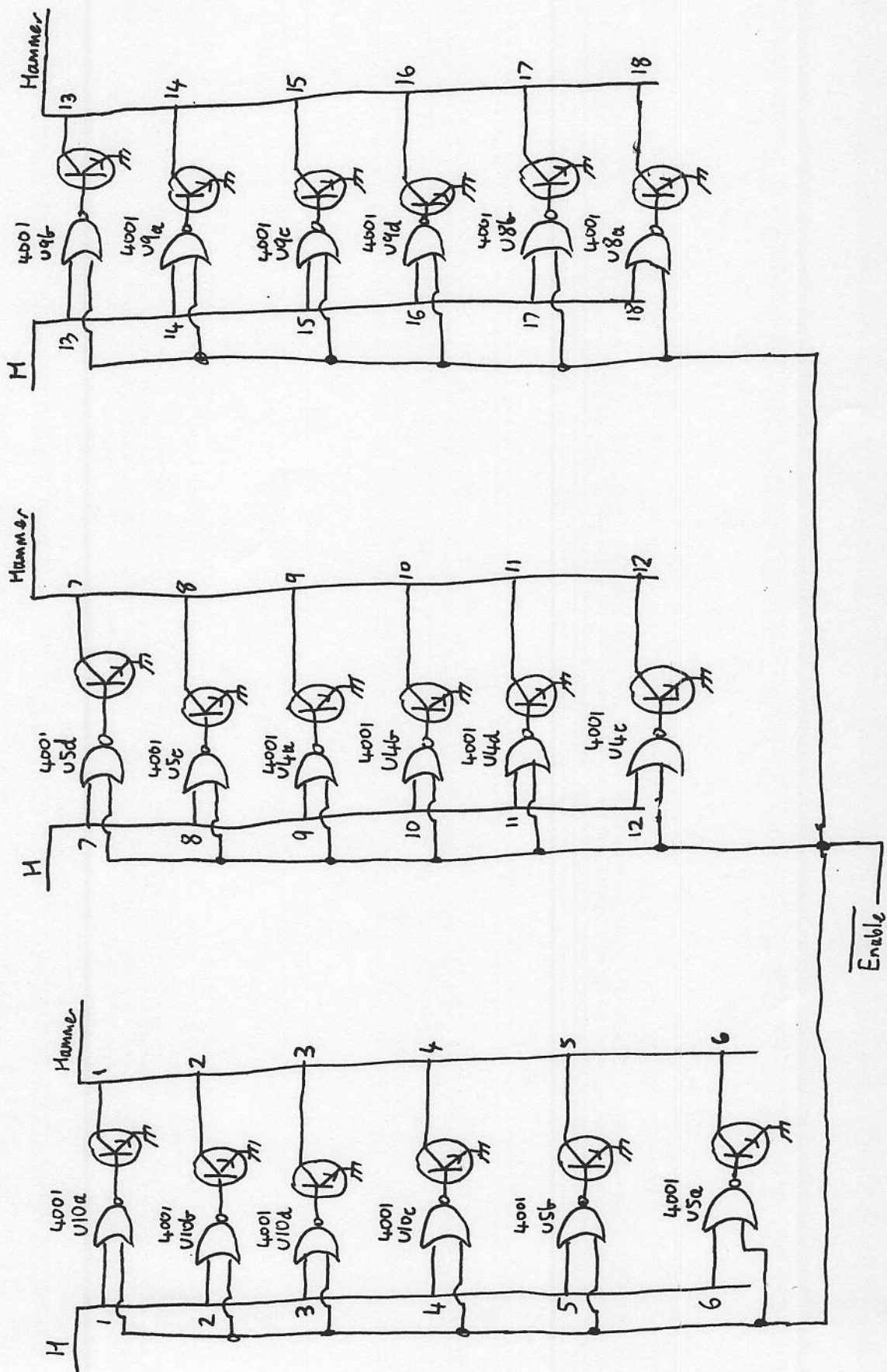

Hammer Drivers

L45

Vunreg

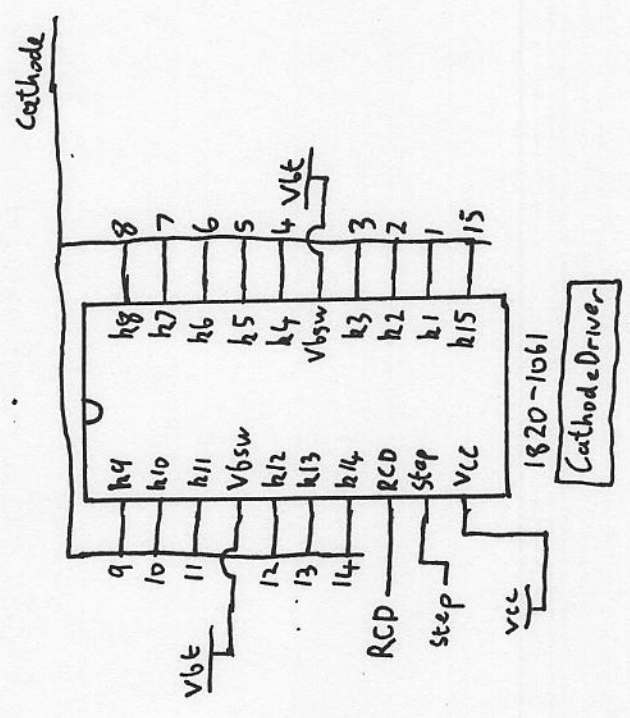
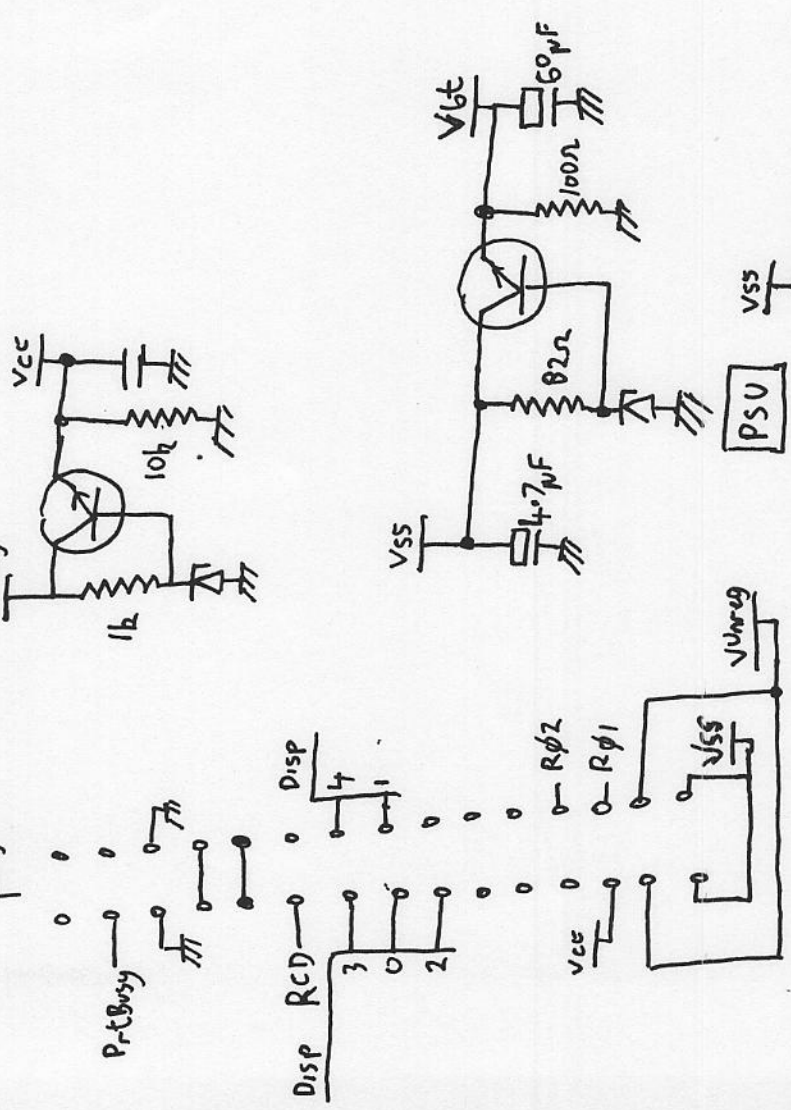
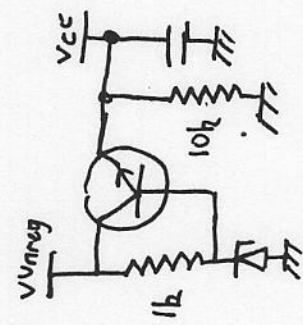

00046-66541

Sheet 1

Display PCB

HP46/HP81

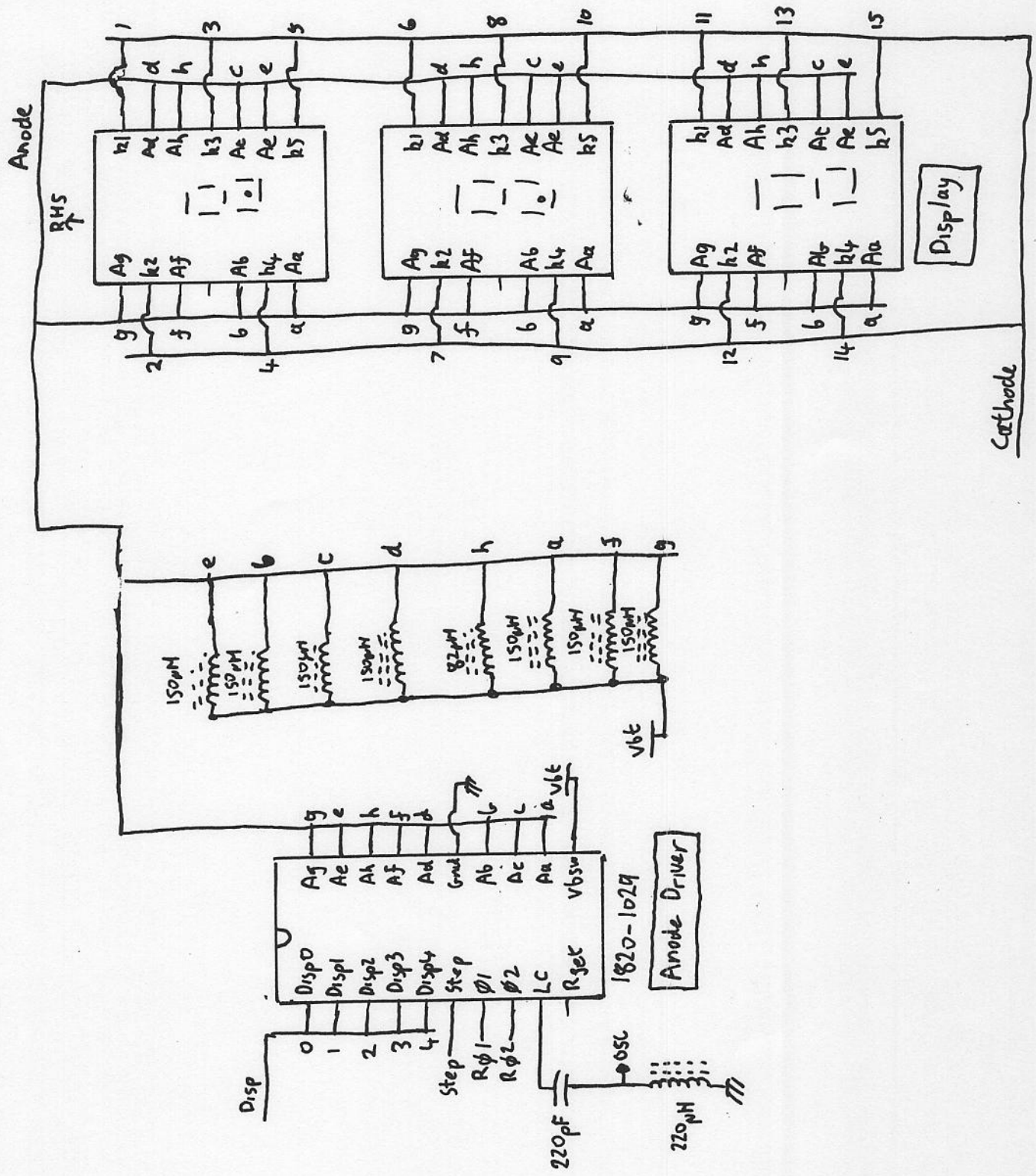

Print Paper

$\frac{1}{x}$	Sin
x^2	cos
LN	Tan
e^x	To Pol
%	$\Sigma +$

Last x
R \downarrow
x^2
ENTER \uparrow

Shift FIX Clear

Chs	EEX	CL x
7	8	9
4	5	6
1	2	3
0		

Line

\div	List
X	RCL
-	STO
+	PRINT

MP46 Keycaps

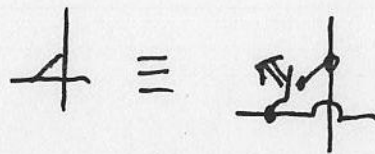
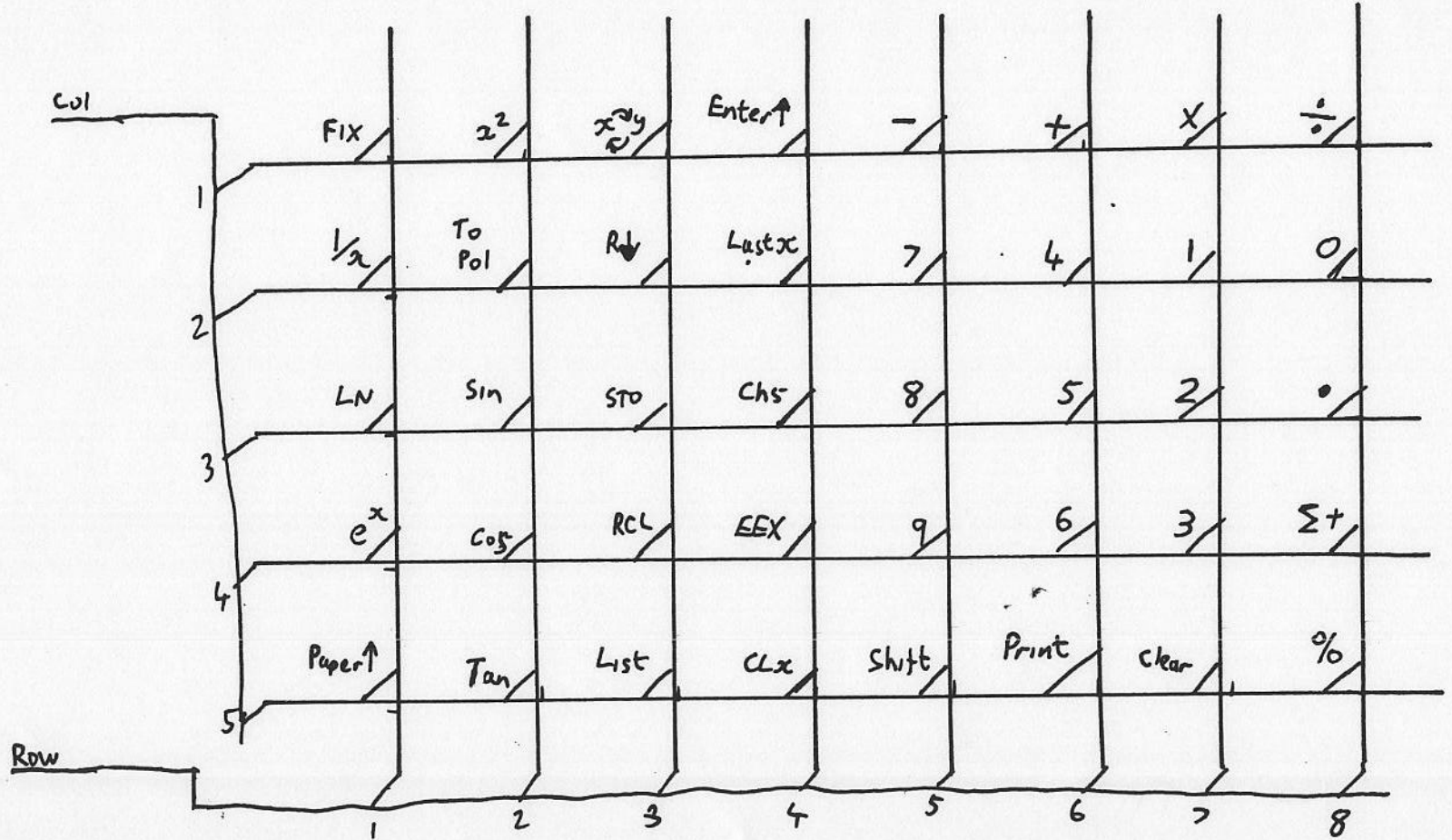
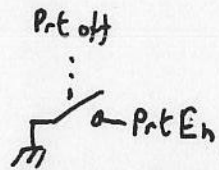
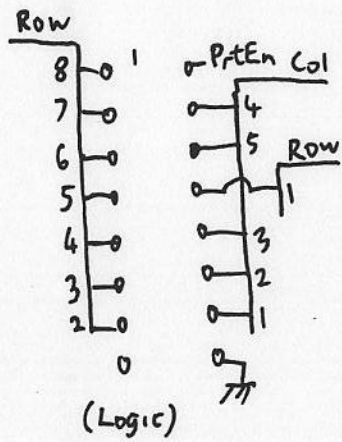

HP46 Keyboard

00046-66530

MP46 Printer Drum

	N	O	T	E	P	O	L	A	R		G	R	D	\bar{x}	T	Δ
	0	0	0	0	0	0	0	0	0	0	+	0	0	→	+	q
#	1	1	1	1	1	1	1	1	1	1	1	1	←	-	1	
	2	2	2	2	2	2	2	2	2	2	2	2	↺	x	2	
	3	3	3	3	3	3	3	3	3	3	3	3	Σ	±	3	
	4	4	4	4	4	4	4	4	4	4	4	4	Δ	%	4	
	5	5	5	5	5	5	5	5	5	5	5	5	√	1/2	5	
	6	6	6	6	6	6	6	6	6	6	6	6	±	3	6	
	7	7	7	7	7	7	7	7	7	7	7	7	e	2	7	
	8	8	8	8	8	8	8	8	8	8	8	8	ln	8		
	-	9	9	9	9	9	9	9	9	9	9	9	10	lg	9	
T	0	D	M	S	I
C	L	E	A	R	E	C	T	L	I	S	T	R	A	D	A	C

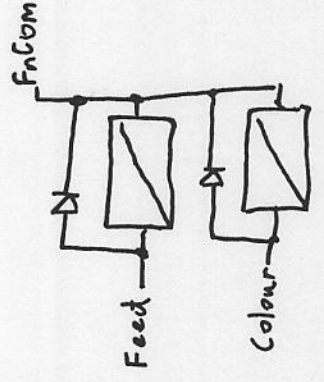
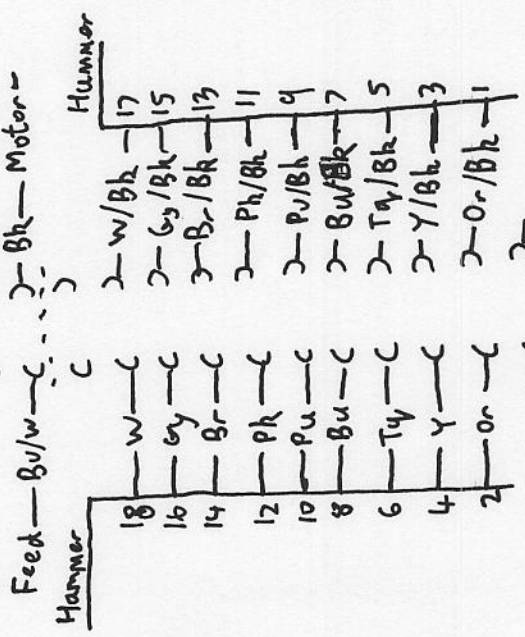
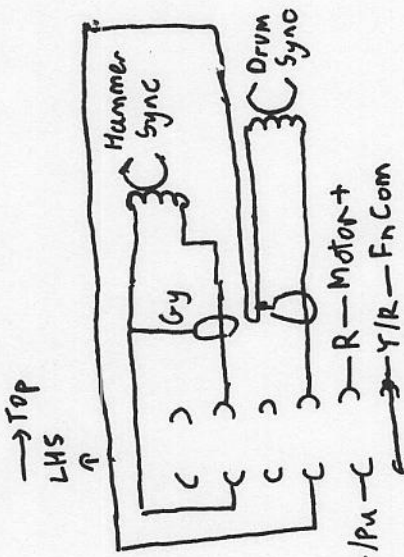

Hammer Solenoids
100Ω

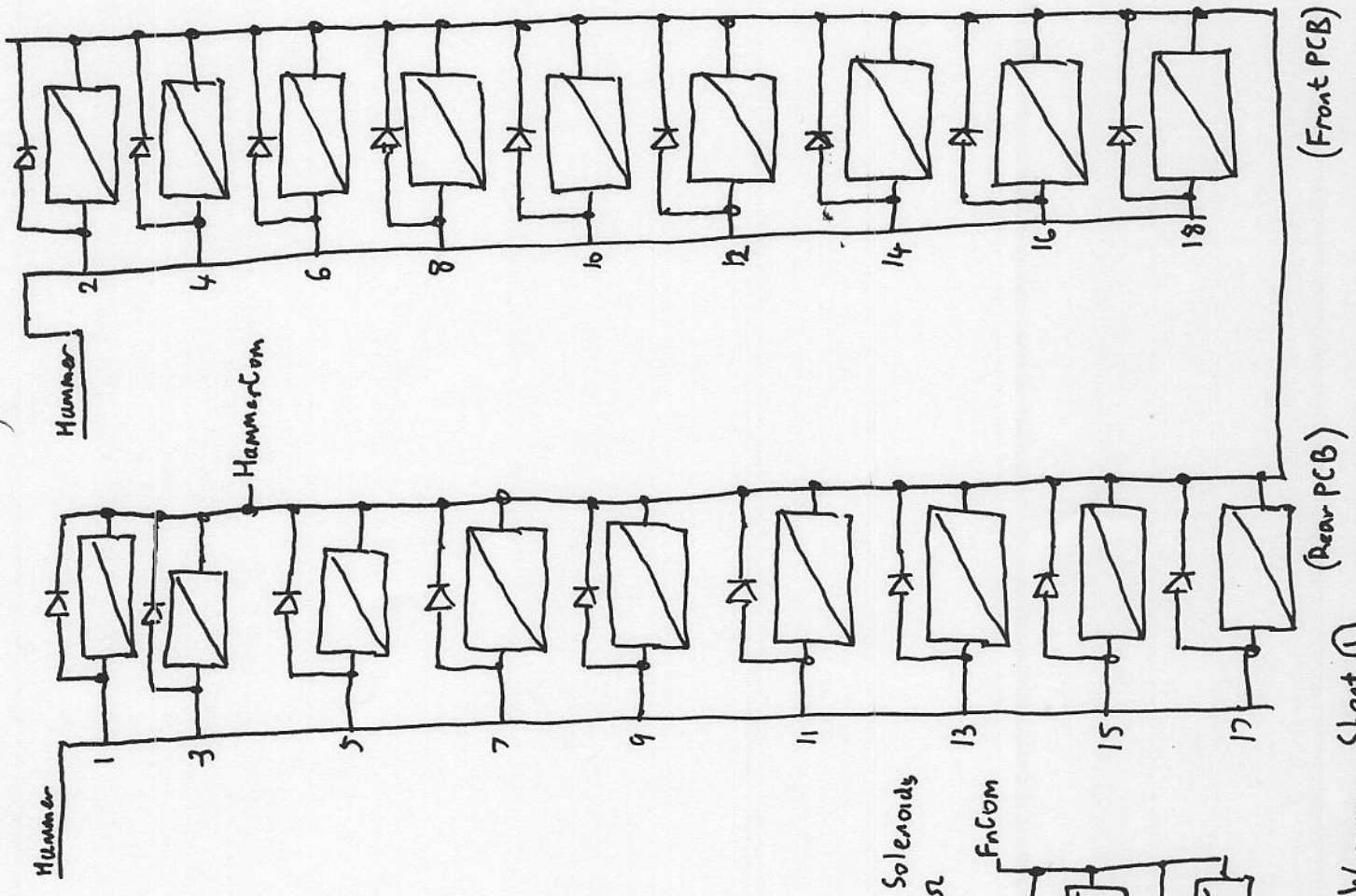

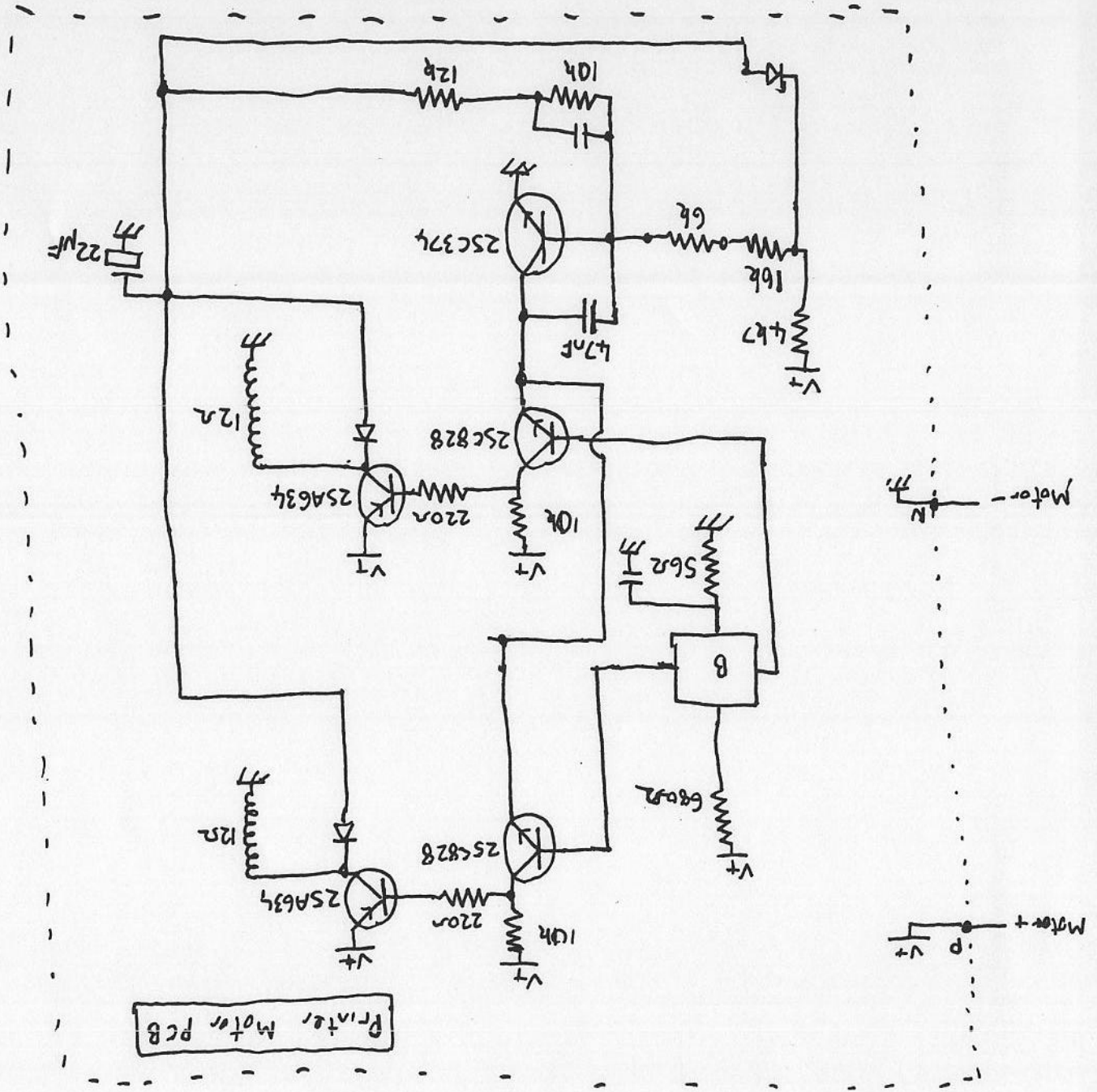

Motor - N

Motor + p v+

Printer Motor PCB

HP46/HP81 Transformer Wiring

